

*Confidential: Piazza PZ-10-54  
 54mil Min Thickness  
 50ksi Min Yield Strength  
 G90 Min Coating Weight*

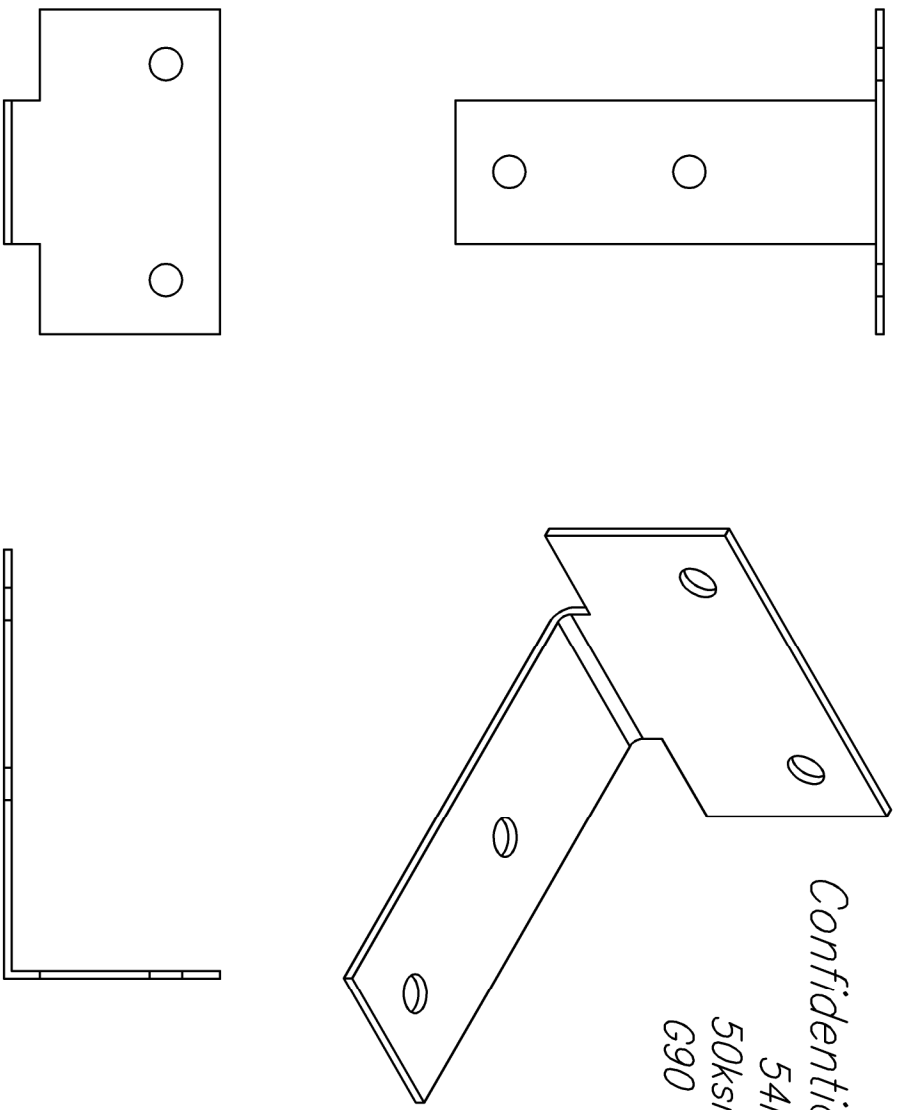

DRAWING NUMBER		PZ-10-54	
DRAWN		CHECKED	
cbs		mjh	
SHEET		DATE	
		2/14/2020	
REVISION			

TITLE	PIAZZA PRODUCT DETAIL
CUSTOMER	PIAZZA STONEWORKS

PROJECT	PIAZZA PART w/ ISO
SHEET TITLE	NO DIMS PIAZZA PZ-10-54

**COPYRIGHT NOTICE**  
 COPYRIGHT IS RETAINED BY  
 PIAZZA STONE LLC. FROM THE DATE OF  
 PUBLICATION OF THESE DOCUMENTS OR  
 THE WORK REPRESENTED BY THEM IS  
 PROHIBITED WITHOUT THE EXPRESS  
 WRITTEN CONSENT OF PIAZZA STONE LLC.

**PIAZZA TRACK AND PIAZZA CLIPS  
 ARE MANUFACTURED  
 EXCLUSIVELY BY  
 THE STEEL NETWORK, INC. (TSN),  
 US Patent #7,503,150  
 www.steelnetwork.com**



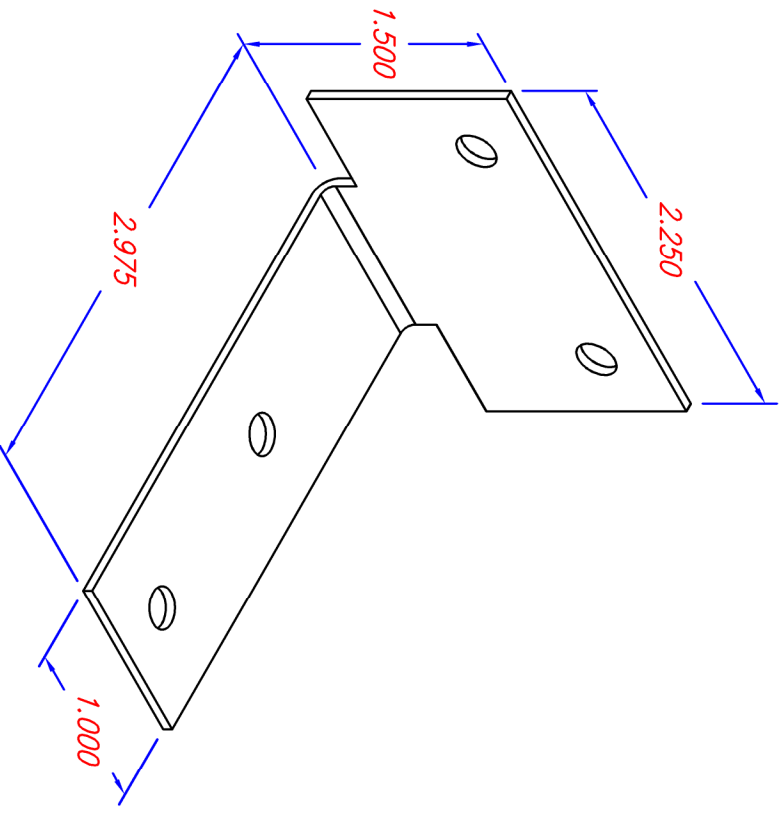

*Confidential: Piazza PZ-10-54*



DRAWING NUMBER		REVISION
PZ-10-54		
DRAWN	CHECKED	
cbs	mjh	
SHEET	DATE	
	2/14/2020	

TITLE	PIAZZA PRODUCT DETAIL
CUSTOMER	PIAZZA STONEWORKS

PROJECT	PIAZZA WEBSITE
SHEET TITLE	PIAZZA PZ-10-54

**COPYRIGHT NOTICE**  
 COPYRIGHT IS RETAINED BY  
 PIAZZA STONE LLC., FROM THE DATE OF  
 PUBLICATION OF THESE DOCUMENTS OR  
 THE WORK REPRESENTED BY THEM IS  
 PROHIBITED WITHOUT THE EXPRESS  
 WRITTEN CONSENT OF PIAZZA STONE LLC.

PIAZZA TRACK AND PIAZZA CLIPS  
 ARE MANUFACTURED  
 EXCLUSIVELY BY  
 THE STEEL NETWORK, INC. (TSN),  
 US Patent #7,503,150  
[www.steelnetwork.com](http://www.steelnetwork.com)



*Confidential: Piazza PZ-18-97*  
*97mil Min Thickness*  
*50ksi Min Yield Strength*  
*G90 Min Coating Weight*

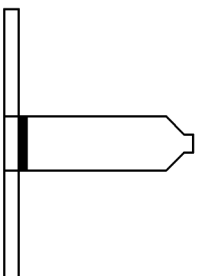
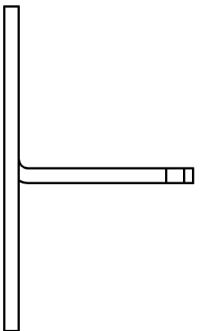
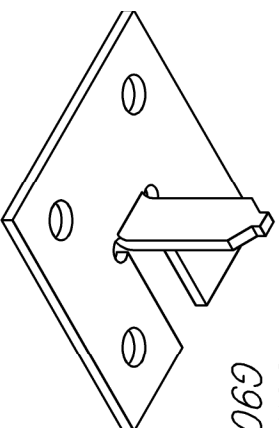
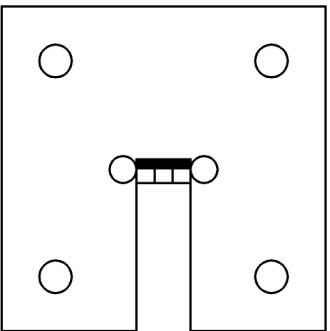

DRAWING NUMBER		REVISION
PZ-18-97		
DRAWN	CHECKED	
cbs	mjh	
SHEET	DATE	
	2/14/2020	

TITLE	PIAZZA PRODUCT DETAIL
CUSTOMER	PIAZZA STONWORKS

PROJECT	PIAZZA PART w/ ISO
SHEET TITLE	NO DIMS
	PIAZZA PZ-18-97

COPYRIGHT NOTICE  
 COPYRIGHT IS RETAINED BY  
 PIAZZA STONE LLC. FROM THE DATE OF  
 PUBLICATION OF THESE DOCUMENTS OR  
 THE WORK REPRESENTED BY THEM IS  
 PROHIBITED WITHOUT THE EXPRESS  
 WRITTEN CONSENT OF PIAZZA STONE LLC.

PIAZZA TRACK AND PIAZZA CLIPS  
 ARE MANUFACTURED  
 EXCLUSIVELY BY  
 THE STEEL NETWORK, INC. (TSN),  
 US Patent #7,503,150  
[www.steelnetwork.com](http://www.steelnetwork.com)

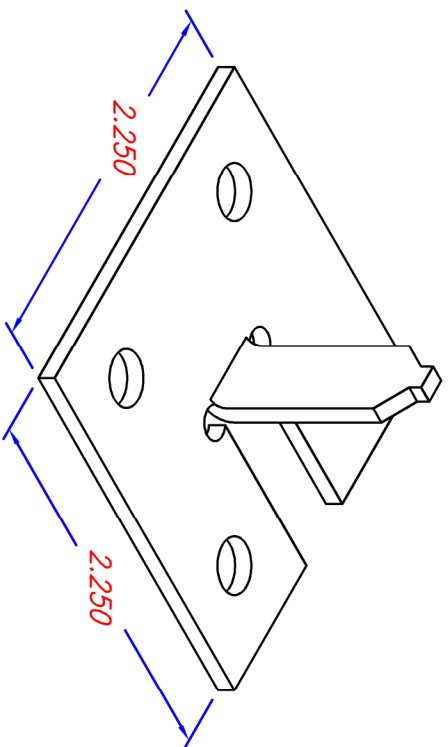

*Confidential: Piazza PZ-18-97*



DRAWING NUMBER		REVISION
PZ-18-97	CHECKED	Δ
DRAWN	mjh	Δ
cbs	DATE	Δ
SHEET	2/14/2020	Δ

TITLE
PIAZZA PRODUCT DETAIL
CUSTOMER
PIAZZA STONWORKS

PROJECT
PIAZZA WEBSITE
SHEET TITLE
PIAZZA PZ-18-97

**COPYRIGHT NOTICE**  
 COPYRIGHT IS RETAINED BY  
 PIAZZA STONE LLC. FROM THE DATE OF  
 PUBLICATION OF THESE DOCUMENTS OR  
 THE WORK REPRESENTED BY THEM IS  
 PROHIBITED WITHOUT THE EXPRESS  
 WRITTEN CONSENT OF PIAZZA STONE LLC.

**PIAZZA TRACK AND PIAZZA CLIPS  
 ARE MANUFACTURED  
 EXCLUSIVELY BY  
 THE STEEL NETWORK, INC. (TSN),  
 US Patent #7,503,150  
[www.steelnetwork.com](http://www.steelnetwork.com)**